

BRASS HOSE BARBS



For clamshell packaged parts add:
PAK to the part number.
Eg... G20B-025:PAK, etc.

Part Number	Pipe Size	Hose I.D.	PRICE EACH			Pkg Qty
			PAK	Loose	Std Pkg	

G20B... BRASS HOSE MENDER



G20B-013	1/8"				\$ 1.70	1
G20B-019	3/16"				1.50	5
G20B-025	1/4"		\$ 1.90		1.70	5
G20B-031	5/16"				1.70	5
G20B-038	3/8"		1.90		1.70	5
G20B-050	1/2"		2.40		2.20	5
G20B-063	5/8"				3.20	1
G20B-075	3/4"				3.90	1

G20B90... 90° BRASS HOSE MENDER



G20B90-025	1/4"				4.50	1
G20B90-038	3/8"				4.60	1
G20B90-050	1/2"				4.60	1
G20B90-063	5/8"				10.80	1
G20B90-075	3/4"				15.40	1

G20BT... BRASS HOSE TEE



G20BT-025	1/4"				4.60	1
G20BT-031	5/16"				4.70	1
G20BT-038	3/8"				4.80	1
G20BT-050	1/2"				7.10	1
G20BT-063	5/8"				8.30	1
G20BT-075	3/4"				21.10	1

G21B... MALE NPT HOSE BARB



G21B-013-013	1/8"	1/8"			1.12	0.98	5
G21B-013-019	1/8"	3/16"			1.18	1.08	5
G21B-013-025	1/8"	1/4"			1.29	1.13	5
G21B-013-031	1/8"	5/16"			1.29	1.14	5
G21B-013-038	1/8"	3/8"			1.52	1.29	5
G21B-025-013	1/4"	1/8"				1.60	1
G21B-025-019	1/4"	3/16"			1.90	1.70	5
G21B-025-025	1/4"	1/4"	1.49		1.29	1.18	5
G21B-025-031	1/4"	5/16"			1.60	1.50	5
G21B-025-038	1/4"	3/8"	1.55		1.35	1.24	5
G21B-025-050	1/4"	1/2"			2.00	1.80	5
G21B-038-025	3/8"	1/4"			2.10	1.90	5
G21B-038-031	3/8"	5/16"			2.30	2.10	5
G21B-038-038	3/8"	3/8"	2.30		2.10	1.80	5
G21B-038-050	3/8"	1/2"	2.40		2.20	1.90	5
G21B-038-063	3/8"	5/8"			2.40	2.20	5
G21B-050-025	1/2"	1/4"			4.60	1	
G21B-050-038	1/2"	3/8"			3.20	3.00	5
G21B-050-050	1/2"	1/2"			3.20	3.00	5
G21B-050-063	1/2"	5/8"			3.80	3.40	5
G21B-050-075	1/2"	3/4"			3.90	3.70	5
G21B-075-050	3/4"	1/2"			7.80	7.00	5
G21B-075-063	3/4"	5/8"			6.90	6.10	5
G21B-075-075	3/4"	3/4"			5.40	4.90	5
G21B-075-100	3/4"	1"			6.30	5.70	5
G21B-100-075	1"	3/4"				10.10	1
G21B-100-100	1"	1"			11.30	10.20	5

Part Number	Pipe Size	Hose I.D.	PRICE EACH			Pkg Qty
			PAK	Loose	Std Pkg	

G21B45... 45° MALE NPT HOSE BARB



G21B45-013-038	1/8"	3/8"			\$ 5.90	1	
G21B45-025-038	1/4"	3/8"			6.10	5	
G21B45-038-038	3/8"	3/8"			9.20	1	
G21B45-038-050	3/8"	1/2"			9.20	8.50	5

G21B90... 90° MALE NPT HOSE BARB

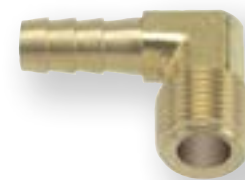

G21B90-013-019	1/8"	3/16"			3.00	1
G21B90-013-025	1/8"	1/4"			3.30	5
G21B90-013-031	1/8"	5/16"			3.30	1
G21B90-013-038	1/8"	3/8"			3.70	5
G21B90-025-025	1/4"	1/4"			3.70	5
G21B90-025-031	1/4"	5/16"			3.30	1
G21B90-025-038	1/4"	3/8"			3.80	5
G21B90-025-050	1/4"	1/2"			5.70	5
G21B90-038-025	3/8"	1/4"			5.50	1
G21B90-038-031	3/8"	5/16"			6.80	1

G21B90-038-038	3/8"	3/8"			4.80	4.20	5
G21B90-038-050	3/8"	1/2"			6.00	5.60	5
G21B90-038-063	3/8"	5/8"			4.80	1	
G21B90-050-038	1/2"	3/8"			14.50	1	
G21B90-050-050	1/2"	1/2"	8.80		7.70	5	
G21B90-050-063	1/2"	5/8"			5.10	1	
G21B90-050-075	1/2"	3/4"			20.20	1	
G21B90-075-075	3/4"	3/4"			19.30	1	

G21BL... MALE NPT EXTRA LONG HOSE BARB



G21BL-075-075	3/4"	3/4"			\$ 9.60	1
---------------	------	------	--	--	---------	---

G21BLM... LIVE MALE NPT SWIVEL HOSE BARB



G21BLM-025-025	1/4"	1/4"			4.80	1
G21BLM-025-038	1/4"	3/8"			5.40	1
G21BLM-038-038	3/8"	3/8"			7.70	1
G21BLM-038-050	3/8"	1/2"			7.70	1
G21BLM-050-050	1/2"	1/2"			8.30	1

G21BRI... REUSABLE MALE NPT HOSE INSERT



G21BRI-025-038	1/4"	3/8"			3.10	1
G21BRI-038-038	3/8"	3/8"	4.00	3.80	3.40	5

G21BRS... REUSABLE HOSE SOCKET



G21BRS-038-063	3/8"	5/8"	4.00	3.80	3.40	5
G21BRS-038-069	3/8"	11/16"			3.80	1
G21BRS-038-075	3/8"	3/4"			3.60	1

7

Brass

BRASS HOSE BARBS

WELDING HOSE FITTINGS

Part Number	Pipe Size	Hose I.D.	PRICE EACH		Pkg Qty
			Loose	Std Pkg	

G22B... FEMALE NPT HOSE BARB



G22B-013-013	1/8"	1/8"		\$ 1.90	1
G22B-013-025	1/8"	1/4"	\$ 1.90	1.70	5
G22B-013-038	1/8"	3/8"	2.90	2.40	5
G22B-025-013	1/4"	1/8"		3.10	1
G22B-025-025	1/4"	1/4"	2.00	1.90	5
G22B-025-031	1/4"	5/16"		2.50	1
G22B-025-038	1/4"	3/8"	2.10	1.90	5
G22B-025-050	1/4"	1/2"		3.30	1
G22B-038-025	3/8"	1/4"		3.00	1
G22B-038-038	3/8"	3/8"		2.90	1
G22B-038-050	3/8"	1/2"	3.80	3.40	5
G22B-050-038	1/2"	3/8"		3.70	1
G22B-050-050	1/2"	1/2"		4.60	1

G22BFS... FEMALE NPSM SWIVEL HOSE BARB



G22BFS-013-019	1/8"	3/16"		3.10	1
G22BFS-013-025	1/8"	1/4"		3.40	1
G22BFS-025-019	1/4"	3/16"		3.60	1
G22BFS-025-025	1/4"	1/4"	2.70	2.40	5
G22BFS-025-031	1/4"	5/16"		3.40	1
G22BFS-025-038	1/4"	3/8"		2.90	1
G22BFS-038-025	3/8"	1/4"	5.20	4.60	5
G22BFS-038-038	3/8"	3/8"	3.30	3.10	5
G22BFS-038-050	3/8"	1/2"		7.00	1
G22BFS-050-050	1/2"	1/2"		4.30	1
G22BFS-075-075	3/4"	3/4"		11.20	1

G21SAE... MALE SAE HOSE BARB



	Tube O.D.				
G21SAE-025-025	1/4"	1/4"		3.00	1
G21SAE-038-025	3/8"	1/4"		3.00	1
G21SAE-038-038	3/8"	3/8"		3.00	1

G22SAE... FEMALE SAE SWIVEL HOSE BARB



	Tube O.D.				
G22SAE-019-019	3/16"	3/16"		2.00	1
G22SAE-025-025	1/4"	1/4"		2.10	1
G22SAE-031-031	5/16"	5/16"		2.50	1
G22SAE-038-025	3/8"	1/4"		2.40	1
G22SAE-038-031	3/8"	5/16"		5.50	1
G22SAE-038-038	3/8"	3/8"		3.10	1
G22SAE-050-050	1/2"	1/2"		4.50	1

Part Number	Pipe Size	PRICE EACH		Pkg Qty
		Loose	Std Pkg	

G42... WELDING HOSE INSERT



G42-019	3/16"	\$ 1.80	\$ 1.70	5
G42-025	1/4"	1.80	1.70	5
G42-031	5/16"		1.80	1
G42-038	3/8"		1.80	1

G4... WELDING HOSE COLLAR



G4-019	3/16"	2.20	1.70	5
G4-025	1/4"	2.40	1.80	5

G40L... ACETYLENE UNION CONNECTOR



G40L	Type	Thread Size			
	Acetylene	9/16-18 Left		\$ 3.30	1

G40R... OXYGEN UNION CONNECTOR



G40R	Oxygen	9/16-18 Right		\$ 3.30	1
------	--------	---------------	--	---------	---

G43... TYPE "B" WELDING HOSE NUT



G43L	Acetylene	9/16-18 Left	1.55	1.33	10
G43R	Oxygen	9/16-18 Right	1.55	1.33	10

G41L... ACETYLENE (LEFT HAND) OUTLET ADAPTER



G41L-025	PipeSize				
	1/4"	9/16-18 Left		3.40	1
G41L-038	3/8"	9/16-18 Left		4.60	1

G41R... OXYGEN (RIGHT HAND) OUTLET ADAPTER



G41R-025	1/4"	9/16-18 Right		3.40	1
G41R-038	3/8"	9/16-18 Right		4.80	1

7

Brass

PUSH-ON FITTINGS

Push-on fittings have aggressive barbs that are designed to work without clamps **ONLY** on push-on hose. They will not hold pressure on ordinary general purpose hoses. Adding clamps when using push-on fittings may cause premature failure due to cutting of the hose tube under the clamp. For general purpose hoses or for applications where clamps are used, we recommend the regular brass hose barbs (see G20B, G21B, G22B, etc.)

Part Number	Hose I.D.	PRICE EACH		Pkg Qty
		Loose	Std Pkg	
G2000... HOSE MENDER				
G2000-04	1/4"	\$ 2.20	\$ 2.00	5
G2000-06	3/8"	2.90	2.50	5
G2000-08	1/2"	4.50	4.10	5
G2000-10	5/8"	7.50	6.70	5
G2000-12	3/4"	9.50	8.60	5



G2002... FEMALE INVERTED FLARE

	Tube Size	Hose I.D.			
G2002-03-04	3/16"	1/4"	\$ 3.70	1	
G2002-04-04	1/4"	1/4"	3.60	1	
G2002-05-04	5/16"	1/4"	3.60	1	
G2002-06-06	3/8"	3/8"	4.20	1	

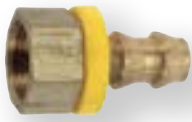

G2001... PLAIN TUBE END

G2001-04-04	1/4"	1/4"	\$ 3.10	1	
G2001-05-04	5/16"	1/4"	3.70	1	
G2001-06-06	3/8"	3/8"	3.60	1	

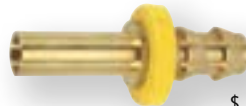

G2016... NPTF MALE

Part Number	Tube Size	Hose I.D.	Loose Price	Std Pkg Price	Pkg Qty
Pipe Size					
G2016-02-04	1/8"	1/4"	\$ 1.80	\$ 1.60	5
G2016-02-06	1/8"	3/8"		3.20	1
G2016-04-04	1/4"	1/4"	2.00	1.80	5
G2016-04-05	1/4"	5/16"	2.50	2.20	5
G2016-04-06	1/4"	3/8"	2.20	1.90	5
G2016-04-08	1/4"	1/2"		4.10	1
G2016-06-04	3/8"	1/4"		3.30	1
G2016-06-06	3/8"	3/8"	2.70	2.20	5
G2016-06-08	3/8"	1/2"	2.90	2.50	5
G2016-06-10	3/8"	5/8"		6.40	1
G2016-08-06	1/2"	3/8"	3.80	3.40	5
G2016-08-08	1/2"	1/2"	3.50	3.30	5
G2016-08-10	1/2"	5/8"	5.30	4.90	5
G2016-08-12	1/2"	3/4"		8.20	1
G2016-12-08	3/4"	1/2"		7.80	1
G2016-12-10	3/4"	5/8"		7.60	1
G2016-12-12	3/4"	3/4"	7.20	6.70	5

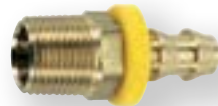

G2012... MALE INVERTED FLARE

	Tube Size	Hose I.D.			
G2012-03-04	3/16"	1/4"	\$ 5.00	1	
G2012-04-04	1/4"	1/4"	3.50	1	
G2012-05-04	5/16"	1/4"	3.60	1	
G2012-06-06	3/8"	3/8"	4.50	1	
G2012-08-08	1/2"	1/2"	8.30	1	
G2012-10-10	5/8"	5/8"		11.20	1



Part Number	Tube Size	Hose I.D.	PRICE EACH		Pkg Qty
			Loose	Std Pkg	
G2004... SAE 45° FEMALE SWIVEL					
G2004-04-04	1/4"	1/4"	\$ 3.20	\$ 2.90	5
G2004-05-04	5/16"	1/4"		3.40	1
G2004-05-05	5/16"	5/16"		9.10	1
G2004-06-06	3/8"	3/8"	3.80	3.40	5
G2004-06-08	3/8"	1/2"		11.10	1
G2004-08-06	1/2"	3/8"		5.80	1
G2004-08-08	1/2"	1/2"	4.20	3.90	5
G2004-08-10	1/2"	5/8"		14.60	1
G2004-10-08	5/8"	1/2"		8.00	1
G2004-10-10	5/8"	5/8"	8.70	7.70	5
G2004-12-12	3/4"	3/4"		8.70	1



G2005... JIC 37° FEMALE SWIVEL

G2005-06-06	3/8"	3/8"	\$ 3.40	\$ 3.20	5
G2005-12-12	3/4"	3/4"	11.20	10.00	5



G2006... FEMALE PIPE SWIVEL BALL SEAT STYLE

	Tube Size	Hose I.D.			
G2006-02-04	1/8"	1/4"	\$ 4.80	1	
G2006-04-04	1/4"	1/4"	4.30	1	
G2006-04-06	1/4"	3/8"	4.90	1	
G2006-06-06	3/8"	3/8"	6.40	1	
G2006-08-08	1/2"	1/2"		7.10	1



G2014... SAE 45° MALE

	Tube Size	Hose I.D.			
G2014-04-04	1/4"	1/4"	\$ 3.30	1	
G2014-05-04	5/16"	1/4"	3.40	1	
G2014-06-06	3/8"	3/8"	3.50	1	
G2014-08-08	1/2"	1/2"	7.20	1	
G2014-10-10	5/8"	5/8"		7.60	1



G2015 JIC 37° MALE

G2015-06-06	3/8"	3/8"	\$ 5.00	1	
-------------	------	------	---------	---	--



G2008... NPT FEMALE SOLID PUSH-ON FITTING

	Tube Size	Hose I.D.			
G2008-02-04	1/8"	1/4"	\$ 2.90	1	
G2008-04-04	1/4"	1/4"	2.90	1	
G2008-06-06	3/8"	3/8"	3.90	1	
G2008-08-08	1/2"	1/2"	5.50	1	



7

Brass

BRASS PIPE FITTINGS



For clamshell packaged parts add:
PAK to the part number.
Eg... G0808B-04-04:PAK, etc.

Note: The pipe fittings shown here are extruded, machined or forged parts. Cast brass parts are available in larger sizes and are listed at the end of this section.

Part Number	Pipe Size	P R I C E E A C H			Pkg Qty
		PAK	Loose	Std Pkg	

G1600B... HEX HEAD PLUG



G1600B-02	1/8"	\$ 0.51	\$ 0.45	5
G1600B-04	1/4"	1.01	0.87	5
G1600B-06	3/8"	1.34	1.14	5
G1600B-08	1/2"	2.50	2.30	5
G1600B-12	3/4"		4.10	1
G1600B-16	1"		14.60	1

G1600HB... HOLLOW HEX HEAD PLUG



G1600HB-02	1/8"	0.73	0.60	5
G1600HB-04	1/4"	1.09	0.96	5
G1600HB-06	3/8"	1.57	1.30	5
G1600HB-08	1/2"	3.00	2.70	5
G1600HB-12	3/4"		6.70	1

G1600SB... BRASS SQUARE HEAD PIPE PLUG



G1600SB-02	1/8"	0.76	0.63	5
G1600SB-04	1/4"	1.09	0.94	5
G1600SB-06	3/8"	1.70	1.60	5
G1600SB-08	1/2"		3.30	1
G1600SB-12	3/4"		7.20	1

G1600SLB... BRASS SLOTTED HEAD PIPE PLUG



G1600SLB-02	1/8"		1.28	1
G1600SLB-04	1/4"		1.14	1
G1600SLB-06	3/8"		3.00	1

G0008B... LOCKNUT



G0008B-02	1/8"		1.29	1
G0008B-04	1/4"		1.90	1
G0008B-06	3/8"		2.20	1
G0008B-08	1/2"		2.10	1
G0008B-12	3/4"		4.20	1

G0800B... CAP



G0800B-02	1/8"		1.10	1
G0800B-04	1/4"		1.42	5
G0800B-06	3/8"	3.20	2.90	5
G0800B-08	1/2"		3.80	1
G0800B-12	3/4"		6.10	1

Part Number	Pipe Size	Pipe Size	Length	P R I C E E A C H		
				PAK	Loose	Std Pkg Qty

G0808BBH BULKHEAD COUPLING



G0808BBH-02-02	1/8"	1/8"	1.50"	\$ 13.00	\$ 11.70	5
G0808BBH-04-04	1/4"	1/4"	1.50"	10.50	9.40	5
G0808BBH-06-06	3/8"	3/8"	1.32"	13.70	11.90	5
G0808BBH-08-08	1/2"	1/2"	1.50"	16.20	14.60	5
G0808BBHS-04-04	1/4"	1/4"	1.00"		9.10	1

G0808BH... STEEL BULKHEAD COUPLING



G0808BH-04-04	1/4"	1/4"	0.95"	7.80	7.10	5
G0808BH-06-06	3/8"	3/8"	1.45"	9.10	8.20	5
G0808BHL-04-04	1/4"	1/4"	1.50"		12.10	1

G0816BH... STEEL BULKHEAD FITTING



G0816BH-08-04	1/2"	1/4"	2.13"		16.10	1
G0816BH-08-06	1/2"	3/8"	2.13"		13.30	1

G0808B... FEMALE COUPLING



G0808B-02-02	1/8"	1/8"		1.90	1.70	1.42	5
G0808B-04-02	1/4"	1/8"				2.00	1
G0808B-04-04	1/4"	1/4"		3.10	2.90	2.50	5
G0808B-06-02	3/8"	1/8"				3.90	1
G0808B-06-04	3/8"	1/4"		2.80	2.40	5	
G0808B-06-06	3/8"	3/8"		3.10	2.90	2.50	5
G0808B-08-04	1/2"	1/4"				3.60	1
G0808B-08-06	1/2"	3/8"				4.10	1
G0808B-08-08	1/2"	1/2"		4.40	4.20	3.90	5
G0808B-12-08	3/4"	1/2"				8.70	1
G0808B-12-12	3/4"	3/4"				6.40	1

G0816B... BUSHING



G0816B-04-02	1/4"	1/8"			0.90	0.76	5
G0816B-06-02	3/8"	1/8"			1.27	1.17	5
G0816B-06-04	3/8"	1/4"		1.34	1.14	0.99	5
G0816B-08-02	1/2"	1/8"				1.80	1
G0816B-08-04	1/2"	1/4"		2.20	2.00	1.70	5
G0816B-08-06	1/2"	3/8"		1.90	1.70	1.60	5
G0816B-12-02	3/4"	1/8"				7.30	1
G0816B-12-04	3/4"	1/4"			3.80	3.40	5
G0816B-12-06	3/4"	3/8"			3.80	3.40	5
G0816B-12-08	3/4"	1/2"			3.30	3.10	5
G0816B-16-04	1"	1/4"				10.10	1
G0816B-16-06	1"	3/8"				9.40	1
G0816B-16-08	1"	1/2"				8.90	1
G0816B-16-12	1"	3/4"				8.60	1

7

Brass

BRASS PIPE FITTINGS

Note: The pipe fittings shown here are extruded, machined or forged parts. Cast brass parts are available in larger sizes and are listed at the end of this section.

Part Number	Male Pipe	Female Pipe	P R I C E PAK	E A C H Loose	Std Pkg	Pkg Qty
-------------	-----------	-------------	---------------	---------------	---------	---------

G1608B... REDUCING ADAPTER



G1608B-01-02	1/16"	1/8"			\$ 8.90	1
G1608B-02-02	1/8"	1/8"	\$ 0.95	0.85	5	
G1608B-02-04	1/8"	1/4"	1.80	1.60	5	
G1608B-02-06	1/8"	3/8"		3.80	1	
G1608B-04-04	1/4"	1/4"	1.80	1.70	5	
G1608B-04-06	1/4"	3/8"	2.90	2.70	5	
G1608B-04-08	1/4"	1/2"		4.20	5	
G1608B-06-06	3/8"	3/8"		2.30	1	
G1608B-06-08	3/8"	1/2"	3.50	3.30	5	
G1608B-08-08	1/2"	1/2"		3.60	1	
G1608B-08-12	1/2"	3/4"		7.10	1	

G1616B... HEX NIPPLE



	Pipe Size	Pipe Size				
G1616B-02-02	1/8"	1/8"	0.83	0.71	5	
G1616B-04-02	1/4"	1/8"	1.70	1.42	5	
G1616B-04-04	1/4"	1/4"	1.66	1.46	5	
G1616B-06-02	3/8"	1/8"	2.90	2.70	5	
G1616B-06-04	3/8"	1/4"	2.10	1.90	5	
G1616B-06-06	3/8"	3/8"	2.10	1.90	5	
G1616B-08-04	1/2"	1/4"		4.20	1	
G1616B-08-06	1/2"	3/8"	3.30	3.10	5	
G1616B-08-08	1/2"	1/2"	3.90	3.70	5	
G1616B-12-08	3/4"	1/2"		5.80	1	
G1616B-12-12	3/4"	3/4"	5.90	5.50	5	
G1616B-16-16	1"	1"		21.00	1	

G1616BC... CLOSE NIPPLE



G1616BC-02	1/8"	0.71	0.59	5	
G1616BC-04	1/4"	0.96	0.90	5	
G1616BC-06	3/8"	1.46	1.24	5	
G1616BC-08	1/2"	2.50	2.20	5	
G1616BC-12	3/4"		5.90	1	
G1616BC-16	1"		8.70	1	
G1616BC-125	1 1/4"		11.40	1	
G1616BC-150	1 1/2"		14.80	1	
G1616BC-200	2"		22.20	1	

Part Number	Male Pipe	Female Pipe	P R I C E PAK	E A C H Loose	Std Pkg	Pkg Qty
-------------	-----------	-------------	---------------	---------------	---------	---------

G1616BL... LONG NIPPLE



G1616BL-02X1.5	1/8"	1.5"		\$ 1.42	1	
G1616BL-02X2	1/8"	2.0"		1.90	1	
G1616BL-02X2.5	1/8"	2.5"		2.50	1	
G1616BL-02X3	1/8"	3.0"		3.70	1	
G1616BL-04X1.5	1/4"	1.5"		1.80	1	
G1616BL-04X2	1/4"	2.0"		2.00	1	
G1616BL-04X2.5	1/4"	2.5"		4.10	1	
G1616BL-04X3	1/4"	3.0"		4.90	1	
G1616BL-06X1.5	3/8"	1.5"		2.90	1	
G1616BL-06X2	3/8"	2.0"		3.60	1	
G1616BL-06X2.5	3/8"	2.5"		4.60	1	
G1616BL-06X3	3/8"	3.0"		5.80	1	
G1616BL-06X4	3/8"	4.0"		7.10	1	
G1616BL-06X4.5	3/8"	4.5"		8.10	1	
G1616BL-06X6	3/8"	6.0"		10.90	1	
G1616BL-08X1.5	1/2"	1.5"		3.30	1	
G1616BL-08X2	1/2"	2.0"		4.80	1	
G1616BL-08X3	1/2"	3.0"		7.50	1	
G1616BL-12X2	3/4"	2.0"		7.50	1	

G1616BL-125X2	1 1/4"	2"		15.20	1	
G1616BL-150X2	1 1/2"	2"		17.70	1	
G1616BL-150X3	1 1/2"	3"		28.10	1	
G1616BL-150X6	1 1/2"	6"		51.70	1	
G1616BL-200X2.5	2"	2.5"		33.10	1	
G1616BL-200X4	2"	4"		34.80	1	
G1616BL-200X6	2"	6"		56.10	1	

G0848B... 45° FEMALE ELBOW



	Pipe Size	Pipe Size				
G0848B-02-02	1/8"	1/8"		5.20	1	
G0848B-04-04	1/4"	1/4"		7.30	1	
G0848B-06-06	3/8"	3/8"		8.50	1	

G0898B... 90° FEMALE ELBOW



G0898B-02-02	1/8"	1/8"		2.20	2.00	5
G0898B-04-04	1/4"	1/4"	3.60	3.40	3.20	5
G0898B-06-06	3/8"	3/8"	5.60	5.40	4.90	5
G0898B-08-08	1/2"	1/2"		8.10	7.30	5
G0898B-12-12	3/4"	3/4"			17.20	1

G1696B... 90° MALE ELBOW



G1696B-02-02	1/8"	1/8"		3.40	1	
G1696B-04-04	1/4"	1/4"		3.70	1	
G1696B-06-06	3/8"	3/8"	5.50	5.10	5	
G1696B-08-06	1/2"	3/8"		9.10	1	
G1696B-08-08	1/2"	1/2"		8.90	1	

G1648B... 45° STREET ELBOW

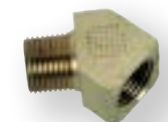

G1648B-02-02	1/8"	1/8"		3.00	2.70	5
G1648B-04-04	1/4"	1/4"		4.00	3.60	5
G1648B-06-06	3/8"	3/8"		5.40	5.00	5
G1648B-08-08	1/2"	1/2"		10.20	9.30	5
G1648B-12-12	3/4"	3/4"			19.00	1

7

Brass

BRASS PIPE FITTINGS

Note: The pipe fittings shown here are extruded, machined or forged parts. Cast brass parts are available in larger sizes and are listed at the end of this section.

Part Number	Male Pipe	Female Pipe	PRICE EACH	Pkg Qty
			PAK	Loose

G1698B... 90° STREET ELBOW



Part Number	Male Size	Female Size	PRICE EACH	Pkg Qty
			PAK	Loose
G1698B-02-02	1/8"	1/8"	\$ 2.30	\$ 2.10
G1698B-02-04	1/8"	1/4"		4.80
G1698B-04-04	1/4"	1/4"	\$ 3.00	2.50
G1698B-04-06	1/4"	3/8"		8.20
G1698B-06-06	3/8"	3/8"	4.00	3.40
G1698B-06-08	3/8"	1/2"		14.10
G1698B-08-08	1/2"	1/2"	7.40	6.30
G1698B-12-12	3/4"	3/4"		16.00

G08X88B... FEMALE PIPE CROSS



Part Number	Pipe Size	Pipe Size	PRICE EACH	Pkg Qty
G08X88B-02-02	1/8"	1/8"		4.60
G08X88B-04-04	1/4"	1/4"		7.00
G08X88B-06-06	3/8"	3/8"		9.40
G08X88B-08-08	1/2"	1/2"		18.00

G08T86B... MALE BRANCH TEE



G08T86B-02-02	1/8"	1/8"		3.60
G08T86B-04-04	1/4"	1/4"		6.30
G08T86B-06-06	3/8"	3/8"		8.60
G08T86B-08-08	1/2"	1/2"		16.10

G08T88B... FEMALE PIPE TEE



G08T88B-02-02	1/8"	1/8"		2.90
G08T88B-04-04	1/4"	1/4"		10.50
G08T88B-04-04	1/4"	1/4"	5.00	4.30
G08T88B-06-06	3/8"	3/8"	6.20	5.60
G08T88B-08-08	1/2"	1/2"		8.60
G08T88B-12-12	3/4"	3/4"		23.30

G16T66B... MALE TEE



G16T66B-02-02	1/8"	1/8"		6.90
G16T66B-04-04	1/4"	1/4"		7.50
G16T66B-06-06	3/8"	3/8"		11.00
G16T66B-08-08	1/2"	1/2"		14.10

Part Number	Male Pipe	Female Pipe	PRICE EACH	Pkg Qty
			Loose	Std Pkg

G16T88B... STREET TEE

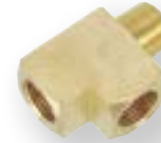

G16T88B-02-02	1/8"	1/8"	\$ 3.50	\$ 3.30
G16T88B-04-04	1/4"	1/4"	4.60	4.20
G16T88B-06-06	3/8"	3/8"	7.70	7.00
G16T88B-08-08	1/2"	1/2"	20.90	19.10

CAST BRASS PIPE FITTINGS

Part Number	Pipe Size	Pipe Size	PRICE EACH	Pkg Qty
-------------	-----------	-----------	------------	---------

G0808B... FEMALE COUPLING



G0808B-100-100	1"	1"	11.40	1
G0808B-125-100	1 1/4"	1"	23.40	1
G0808B-125-125	1 1/4"	1 1/4"	19.40	1
G0808B-150-150	1 1/2"	1 1/2"	24.10	1
G0808B-200-200	2"	2"	39.60	1

G0816B... BUSHING



G0816B-125-050	1 1/4"	1/2"	17.50	1
G0816B-125-075	1 1/4"	3/4"	12.20	1
G0816B-125-100	1 1/4"	1"	12.20	1
G0816B-150-100	1 1/2"	1"	16.40	1
G0816B-150-125	1 1/2"	1 1/4"	16.40	1
G0816B-200-150	2"	1 1/2"	22.00	1

G0848B... 45° FEMALE ELBOW



G0848B-050-050	1/2"	1/2"	6.30	1
G0848B-075-075	3/4"	3/4"	10.90	1
G0848B-100-100	1"	1"	19.20	1
G0848B-125-125	1 1/4"	1 1/4"	30.50	1
G0848B-150-150	1 1/2"	1 1/2"	38.50	1

G0898B... 90° FEMALE ELBOW



G0898B-075-075	3/4"	3/4"	9.10	1
G0898B-100-100	1"	1"	14.70	1
G0898B-125-125	1 1/4"	1 1/4"	23.70	1
G0898B-150-150	1 1/2"	1 1/2"	29.50	1
G0898B-200-200	2"	2"	47.50	1

CAST BRASS PIPE FITTINGS

SAE 45° FLARE FITTINGS

Part Number	Pipe Size	Pipe Size	PRICE EACH	Pkg Qty
-------------	-----------	-----------	------------	---------

G1648B... 45° STREET ELBOW



G1648B-075-075	3/4"	3/4"	\$ 15.60	1
G1648B-100-100	1"	1"	21.30	1
G1648B-125-125	1 1/4"	1 1/4"	32.40	1
G1648B-150-150	1 1/2"	1 1/2"	43.40	1

G1698B... 90° STREET ELBOW



G1698B-075-075	3/4"	3/4"	10.60	1
G1698B-100-100	1"	1"	17.30	1
G1698B-125-125	1 1/4"	1 1/4"	30.50	1
G1698B-150-150	1 1/2"	1 1/2"	37.60	1
G1698B-200-200	2"	2"	69.00	1

G08T88B... FEMALE TEE



G08T88B-075-075	3/4"	3/4"	12.60	1
G08T88B-100-100	1"	1"	19.50	1
G08T88B-125-125	1 1/4"	1 1/4"	29.80	1
G08T88B-150-150	1 1/2"	1 1/2"	39.50	1
G08T88B-200-200	2"	2"	65.50	1

SAE 45° FLARE FITTINGS

Part Number	Tube Size	PRICE EACH	Pkg Qty
		Loose Std Pkg	

G0014... MACHINED FLARE NUT



G0014-03	3/16"	0.80	1
G0014-04	1/4"	0.76	5
G0014-05	5/16"	0.96	1
G0014-06	3/8"	1.63	5
G0014-08	1/2"	2.00	5

G0014-10	5/8"	2.90	1
----------	------	------	---

G0014F... FORGED FLARE NUT



G0014F-04	1/4"	1.24	1
G0014F-05	5/16"	2.70	1
G0014F-06	3/8"	2.00	5
G0014F-08	1/2"	2.50	1
G0014F-10	5/8"	3.90	1

G0014F-12	3/4"	10.20	1
-----------	------	-------	---

Part Number	Tube Size	PRICE EACH	Pkg Qty
		Loose Std Pkg	

G0014L... LONG MACHINED FLARE NUT

G0014L-04	1/4"	\$ 1.12	1
G0014L-05	5/16"	1.50	1
G0014L-06	3/8"	2.00	1
G0014L-08	1/2"	4.20	1
G0014L-10	5/8"	7.00	1

G0014L-12	3/4"	15.60	1
-----------	------	-------	---

G0400... SAE CAP

G0400-04	1/4"	\$ 0.71	0.59	5
G0400-05	5/16"		2.30	1
G0400-06	3/8"	1.42	1.14	5
G0400-08	1/2"	1.70	1.42	5
G0400-10	5/8"	2.30	2.20	5

G0400-12	3/4"	12.70	1
----------	------	-------	---

G0404... SAE FEMALE UNION



G0404-04-04	1/4"	7.70	1
G0404-06-06	3/8"	11.30	1
G0404-08-08	1/2"	30.30	1

G0404SW... SAE FEMALE SWIVEL UNION



G0404SW-04-04	1/4"	7.60	1
G0404SW-05-05	5/16"	10.70	1
G0404SW-06-06	3/8"	9.00	1
G0404SW-08-08	1/2"	10.50	1
G0404SW-10-10	5/8"	14.70	1

G0404SW-12-12	3/4"	30.30	1
---------------	------	-------	---

G0414 FEMALE FLARE TO MALE FLARE

	Female	Male		
G0414-04-06	1/4"	3/8"	5.90	1
G0414-06-04	3/8"	1/4"	5.00	1
G0414-06-08	3/8"	1/2"	5.90	1
G0414-08-06	1/2"	3/8"	6.50	1
G0414-08-10	1/2"	5/8"	9.80	1

G0414-10-08	5/8"	1/2"	9.90	1
G0414-10-12	5/8"	3/4"	22.00	1

G0416 FEMALE FLARE TO MALE PIPE

	Pipe	Tube		
G0416-02-04	1/8"	1/4"	6.10	1
G0416-04-04	1/4"	1/4"	6.90	1
G0416-04-06	1/4"	3/8"	10.00	1
G0416-06-08	3/8"	1/2"	14.90	1
G0416-08-08	1/2"	1/2"	15.40	1

G1400 SAE PLUG



G1400-04	1/4"	1.29	1.07	5
G1400-05	5/16"		3.90	1
G1400-06	3/8"	1.63	1.42	5
G1400-08	1/2"	2.50	2.20	5
G1400-10	5/8"		3.40	1

G1400-12	3/4"	21.40	1
----------	------	-------	---

7

Brass

SAE 45° FLARE FITTINGS

Part Number	Pipe Size	Tube Size	PRICE EACH		Pkg Qty
			Loose	Std Pkg	
G1408 FEMALE CONNECTOR					
G1408-02-03	1/8"	3/16"		\$ 3.00	1
G1408-02-04	1/8"	1/4"		1.07	1
G1408-02-05	1/8"	5/16"		2.30	1
G1408-02-06	1/8"	3/8"		2.30	1
G1408-04-04	1/4"	1/4"		1.60	1
G1408-04-05	1/4"	5/16"		4.60	1
G1408-04-06	1/4"	3/8"		1.70	1
G1408-04-08	1/4"	1/2"		7.40	1
G1408-06-04	3/8"	1/4"		5.30	1
G1408-06-06	3/8"	3/8"		2.10	1
G1408-06-08	3/8"	1/2"		3.00	1
G1408-06-10	3/8"	5/8"		7.80	1
G1408-08-04	1/2"	1/4"		7.30	1
G1408-08-06	1/2"	3/8"		2.90	1
G1408-08-08	1/2"	1/2"		3.30	1
G1408-08-10	1/2"	5/8"		4.50	1
G1408-08-12	1/2"	3/4"		21.60	1
G1408-12-08	3/4"	1/2"		5.60	1
G1408-12-10	3/4"	5/8"		7.00	1
G1408-12-12	3/4"	3/4"		21.60	1



G1446... 45° MALE CONNECTOR

Part Number	Pipe Size	Tube Size	PRICE EACH		Pkg Qty
			Loose	Std Pkg	
G1446-02-04	1/8"	1/4"		\$ 2.70	1
G1446-02-05	1/8"	5/16"		6.10	1
G1446-04-04	1/4"	1/4"		4.10	1
G1446-04-05	1/4"	5/16"		4.60	1
G1446-04-06	1/4"	3/8"	\$ 4.00	3.70	5
G1446-06-06	3/8"	3/8"		5.30	1
G1446-06-08	3/8"	1/2"		4.90	1
G1446-08-06	1/2"	3/8"		8.70	1
G1446-08-08	1/2"	1/2"		11.20	1
G1446-08-10	1/2"	5/8"		9.60	1
G1446-08-12	1/2"	3/4"		18.90	1
G1446-12-12	3/4"	3/4"		13.90	1



G1494... 90° UNION ELBOW

Part Number	Tube Size		PRICE EACH	Pkg Qty
	Pipe Size	Tube Size		
G1494-04-04	1/4"	1/4"	3.40	1
G1494-05-05	5/16"	5/16"	5.20	1
G1494-06-06	3/8"	3/8"	5.60	1
G1494-08-08	1/2"	1/2"	4.90	1
G1494-10-10	5/8"	5/8"	12.50	1
G1494-12-12	3/4"	3/4"	22.20	1



G1414 UNION

Part Number	Tube Size		PRICE EACH	Pkg Qty
	Pipe Size	Tube Size		
G1414-02-02	1/8"	1/8"	2.40	1
G1414-04-04	1/4"	1/4"	1.18	5
G1414-05-05	5/16"	5/16"	2.00	1
G1414-06-04	3/8"	1/4"	2.00	1
G1414-06-05	3/8"	5/16"	7.70	1
G1414-06-06	3/8"	3/8"	2.10	5
G1414-08-04	1/2"	1/4"	8.50	1
G1414-08-06	1/2"	3/8"	2.90	1
G1414-08-08	1/2"	1/2"	3.30	5
G1414-10-06	5/8"	3/8"	3.70	1
G1414-10-08	5/8"	1/2"	4.50	1
G1414-10-10	5/8"	5/8"	4.20	5
G1414-12-12	3/4"	3/4"	12.10	1



G1496... 90° MALE CONNECTOR

Part Number	Pipe Size		PRICE EACH	Pkg Qty
	Pipe Size	Tube Size		
G1496-02-02	1/8"	1/8"	12.80	1
G1496-02-03	1/8"	3/16"	6.00	1
G1496-02-04	1/8"	1/4"	2.50	5
G1496-02-05	1/8"	5/16"	2.70	1
G1496-02-06	1/8"	3/8"	3.20	1
G1496-04-04	1/4"	1/4"	2.70	5
G1496-04-05	1/4"	5/16"	4.60	1
G1496-04-06	1/4"	3/8"	3.70	5
G1496-04-08	1/4"	1/2"	5.90	1
G1496-06-04	3/8"	1/4"	3.60	1
G1496-06-05	3/8"	5/16"	6.50	1
G1496-06-06	3/8"	3/8"	3.40	5
G1496-06-08	3/8"	1/2"	5.20	5
G1496-06-10	3/8"	5/8"	7.10	1
G1496-08-04	1/2"	1/4"	9.00	1
G1496-08-06	1/2"	3/8"	4.20	1
G1496-08-08	1/2"	1/2"	5.50	5
G1496-08-10	1/2"	3/8"	6.80	5
G1496-08-12	1/2"	3/4"	14.30	1
G1496-12-08	3/4"	1/2"	8.90	1
G1496-12-10	3/4"	5/8"	9.60	1
G1496-12-12	3/4"	3/4"	20.20	1



7

Brass

SAE 45° FLARE FITTINGS

Part Number	Pipe Size	Tube Size	PRICE EACH		Pkg Qty
			Loose	Std Pkg	

G1498... 90° FEMALE CONNECTOR



G1498-02-04	1/8"	1/4"	\$ 3.90	1
G1498-02-05	1/8"	5/16"	4.60	1
G1498-02-06	1/8"	3/8"	4.90	1
G1498-04-04	1/4"	1/4"	4.80	1
G1498-04-05	1/4"	5/16"	5.40	1
G1498-04-06	1/4"	3/8"	4.90	1
G1498-04-08	1/4"	1/2"	8.70	1
G1498-06-06	3/8"	3/8"	3.80	1
G1498-06-08	3/8"	1/2"	5.30	1
G1498-06-10	3/8"	5/8"	14.10	1
G1498-08-06	1/2"	3/8"	7.80	1
G1498-08-08	1/2"	1/2"	6.50	1
G1498-08-10	1/2"	5/8"	11.20	1
G1498-08-12	1/2"	3/4"	23.90	1
G1498-12-08	3/4"	1/2"	8.90	1
G1498-12-10	3/4"	5/8"	14.40	1
G1498-12-12	3/4"	3/4"	35.30	1

G14T44... UNION TEE



Part Number	Pipe	Tube	PRICE EACH		Pkg Qty
			Loose	Std Pkg	
G14T44-04-04	1/4"	1/4"	4.30	1	
G14T44-05-05	5/16"	5/16"	6.00	1	
G14T44-06-06	3/8"	3/8"	4.10	1	
G14T44-08-08	1/2"	1/2"	6.30	1	
G14T44-10-10	5/8"	5/8"	14.50	1	
G14T44-12-12	3/4"	3/4"	25.10	1	

G14T46... MALE BRANCH TEE



Part Number	Pipe	Tube	PRICE EACH		Pkg Qty
			Loose	Std Pkg	
G14T46-02-04	1/8"	1/4"	4.60	1	
G14T46-02-05	1/8"	5/16"	4.90	1	
G14T46-04-04	1/4"	1/4"	5.80	1	
G14T46-04-05	1/4"	5/16"	8.10	1	
G14T46-04-06	1/4"	3/8"	5.30	1	
G14T46-06-06	3/8"	3/8"	8.90	1	
G14T46-06-08	3/8"	1/2"	12.50	1	
G14T46-08-06	1/2"	3/8"	11.20	1	
G14T46-08-08	1/2"	1/2"	14.70	1	
G14T46-08-10	1/2"	5/8"	18.20	1	
G14T46-08-12	1/2"	3/4"	38.80	1	
G14T46-12-12	3/4"	3/4"	37.70	1	

G14T64... MALE RUN TEE



Part Number	Pipe	Tube	PRICE EACH		Pkg Qty
			Loose	Std Pkg	
G14T64-02-04	1/8"	1/4"	5.10	1	
G14T64-02-05	1/8"	5/16"	6.50	1	
G14T64-04-04	1/4"	1/4"	6.40	1	
G14T64-04-05	1/4"	5/16"	10.20	1	
G14T64-04-06	1/4"	3/8"	7.80	1	
G14T64-06-06	3/8"	3/8"	9.40	1	
G14T64-06-08	3/8"	1/2"	12.60	1	
G14T64-08-08	1/2"	1/2"	16.60	1	
G14T64-08-10	1/2"	5/8"	18.00	1	
G14T64-08-12	1/2"	3/4"	29.30	1	

Part Number	Pipe Size	Tube Size	PRICE EACH		Pkg Qty
			Loose	Std Pkg	

G14X44... CROSS



Part Number	Pipe Size	Tube Size	PRICE EACH		Pkg Qty
			Loose	Std Pkg	
G14X44-04-04	1/4"	1/4"	\$ 14.30	1	
G14X44-06-06	3/8"	3/8"	7.70	1	

INVERTED FLARE FITTINGS

Part Number	Inv. Flare	Male Flare	PRICE EACH		Pkg Qty
			Loose	Std Pkg	

G1412... INVERTED FLARE CONNECTOR



G1412-03-04	3/16"	1/4"	14.20	1
G1412-04-04	1/4"	1/4"	14.10	1
G1412-04-06	1/4"	3/8"	49.10	1
G1412-05-04	5/16"	1/4"	14.10	1
G1412-05-06	5/16"	3/8"	14.10	1
G1412-06-06	3/8"	3/8"	15.40	1
G1412-07-06	7/16"	3/8"	20.70	1

G0012... INVERTED FLARE BRASS NUT



Part Number	Tube	PRICE EACH		Pkg Qty
		Loose	Std Pkg	
G0012-03	3/16"	0.58	1	
G0012-04	1/4"	0.77	1	
G0012-05	5/16"	0.96	1	
G0012-06	3/8"	1.41	1	
G0012-08	1/2"	3.00	1	

G0012S... INVERTED FLARE STEEL NUT



G0012S-03	3/16"	0.39	0.35	5
G0012S-04	1/4"	0.40	0.36	5
G0012S-05	5/16"		0.80	1
G0012S-06	3/8"		0.68	1
G0012S-08	1/2"		1.70	1
G0012S-10	5/8"		4.80	1

G0012SL... INVERTED FLARE LONG STEEL NUT



G0012SL-03	3/16"	0.80	1
G0012SL-04	1/4"	1.00	1

G1200... INVERTED FLARE BRASS PLUG



G1200-03	3/16"	1.46	1
G1200-04	1/4"	1.29	1
G1200-05	5/16"	2.00	1
G1200-06	3/8"	2.40	1

7

Brass

INVERTED FLARE FITTINGS

Part Number	Tube Size	Tube Size	PRICE EACH		Pkg Qty
			Loose	Std Pkg	

G0202... INVERTED FLARE COUPLING



G0202-02-02	1/8"	1/8"		\$ 4.20	1
G0202-03-03	3/16"	3/16"	\$ 1.90	1.80	5
G0202-04-04	1/4"	1/4"	3.00	2.80	5
G0202-05-05	5/16"	5/16"		2.00	1
G0202-06-06	3/8"	3/8"		3.90	1
G0202-08-08	1/2"	1/2"		11.20	1

G0208... INVERTED FLARE FEMALE CONNECTOR



	Pipe	Tube			
G0208-02-03	1/8"	3/16"		3.40	1
G0208-02-04	1/8"	1/4"		2.90	1
G0208-02-05	1/8"	5/16"		5.20	1
G0208-04-06	1/4"	3/8"		7.20	1
G0208-06-08	3/8"	1/2"		10.80	1

G0216... INVERTED FLARE MALE CONNECTOR



G0216-02-03	1/8"	3/16"		1.01	1
G0216-02-04	1/8"	1/4"		1.30	1
G0216-02-05	1/8"	5/16"		1.07	1
G0216-02-06	1/8"	3/8"		3.80	1
G0216-04-04	1/4"	1/4"		2.00	1
G0216-04-05	1/4"	5/16"		2.20	1
G0216-04-06	1/4"	3/8"		1.60	1
G0216-04-08	1/4"	1/2"		5.90	1
G0216-06-06	3/8"	3/8"		3.70	1
G0216-06-08	3/8"	1/2"		2.70	1
G0216-08-08	1/2"	1/2"		5.60	1
G0216-08-10	1/2"	5/8"		9.00	1
G0216-12-12	3/4"	3/4"		29.70	1

G0246... INVERTED FLARE 45° MALE CONNECTOR



G0246-02-03	1/8"	3/16"		5.20	1
G0246-02-04	1/8"	1/4"		3.50	1
G0246-02-05	1/8"	5/16"		5.60	1
G0246-04-06	1/4"	3/8"		7.80	1
G0246-06-08	3/8"	1/2"		11.30	1

Part Number	Pipe Size	Tube Size	PRICE EACH		Pkg Qty
			Loose	Std Pkg	

G0296... INVERTED FLARE 90° MALE CONNECTOR



G0296-02-02	1/8"	1/8"	\$ 6.50		1
G0296-02-03	1/8"	3/16"		2.40	1
G0296-02-04	1/8"	1/4"		1.80	1
G0296-02-05	1/8"	5/16"		2.50	1
G0296-02-06	1/8"	3/8"		10.40	1
G0296-04-04	1/4"	1/4"		3.40	1
G0296-04-05	1/4"	5/16"		3.80	1
G0296-04-06	1/4"	3/8"		5.10	1
G0296-04-08	1/4"	1/2"		11.00	1
G0296-06-06	3/8"	3/8"		7.60	1
G0296-06-08	3/8"	1/2"		9.00	1
G0296-06-10	3/8"	5/8"		26.20	1
G0296-08-08	1/2"	1/2"		16.20	1
G0296-08-10	1/2"	5/8"		17.90	1
G0296-08-12	1/2"	3/4"		45.30	1

G0298... INVERTED FLARE 90° FEMALE CONNECTOR



G0298-02-04	1/8"	1/4"	6.50		1
G0298-02-05	1/8"	5/16"	6.50		1
G0298-04-06	1/4"	3/8"	8.10		1

G02T00... INVERTED FLARE UNION TEE



	Tube	Tube			
G02T00-03-03	3/16"	3/16"		5.40	1
G02T00-04-04	1/4"	1/4"		6.40	1
G02T00-05-05	5/16"	5/16"		8.70	1
G02T00-06-06	3/8"	3/8"		19.20	1

G02T06... INVERTED FLARE MALE BRANCH TEE



	Pipe	Tube			
G02T06-02-04	1/8"	1/4"		10.90	1
G02T06-02-05	1/8"	3/16"		11.20	1
G02T06-04-06	1/4"	3/8"		15.40	1
G02T06-06-08	3/8"	1/2"		28.00	1

7

Brass

BRASS COMPRESSION FITTINGS

Part Number	Tube Size	PRICE EACH		Pkg Qty
		Loose	Std Pkg	
G6000... BRASS COMPRESSION SLEEVE				
G6000-02	1/8"	\$ 0.17	\$ 0.12	5
G6000-03	3/16"	0.19	0.13	5
G6000-04	1/4"	0.18	0.14	5
G6000-05	5/16"	0.34	0.20	5
G6000-06	3/8"	0.37	0.21	5
G6000-08	1/2"	0.39	0.36	5
G6000-10	5/8"		0.45	1
G6000-12	3/4"		1.41	1

G6100... PLASTIC COMPRESSION SLEEVE				
Tube O.D.				
G6100-04	1/4"	0.24	0.22	5
G6100-05	5/16"		0.74	1
G6100-06	3/8"	0.27	0.24	5
G6100-08	1/2"	0.71	0.59	5
G6100-10	5/8"		0.83	1

G6001... STANDARD NUT				
Tube				
G6001-02	1/8"		0.48	1
G6001-03	3/16"		0.50	1
G6001-04	1/4"	0.51	0.46	5
G6001-05	5/16"		0.56	1
G6001-06	3/8"	0.71	0.57	5
G6001-08	1/2"		1.13	1
G6001-10	5/8"		1.42	1
G6001-12	3/4"		4.30	1

G6103... COMPRESSION INSERT				
Tube O.D.				
G6103-04	1/4"	0.24	0.22	5
G6103-05	5/16"	0.75	0.69	5
G6103-06	3/8"	0.35	0.33	5
G6103-08	1/2"	1.18	1.08	5
G6103-10	5/8"		1.60	1

G6008... FEMALE CONNECTOR				
Pipe	Tube			
G6008-02-02	1/8"	1/8"	2.30	1
G6008-02-03	1/8"	3/16"	2.90	1
G6008-02-04	1/8"	1/4"	1.80	1
G6008-02-05	1/8"	5/16"	3.00	1
G6008-02-06	1/8"	3/8"	3.40	1
G6008-04-04	1/4"	1/4"	1.90	1
G6008-04-05	1/4"	5/16"	4.20	1
G6008-04-06	1/4"	3/8"	2.20	1
G6008-06-04	3/8"	1/4"	7.10	1
G6008-06-06	3/8"	3/8"	2.50	1
G6008-06-08	3/8"	1/2"	4.50	1
G6008-06-10	3/8"	5/8"	9.00	1
G6008-08-04	1/2"	1/4"	9.60	1
G6008-08-06	1/2"	3/8"	4.90	1
G6008-08-08	1/2"	1/2"	5.00	1
G6008-08-10	1/2"	5/8"	4.90	1
G6008-08-12	1/2"	3/4"	22.80	1
G6008-12-08	3/4"	1/2"	14.50	1
G6008-12-10	3/4"	5/8"	16.00	1
G6008-12-12	3/4"	3/4"	25.40	1

Part Number	Tube Size	Tube Size	PRICE EACH		Pkg Qty
			Loose	Std Pkg	
G6060... UNION					
G6060-02-02	1/8"	1/8"	\$ 2.90		1
G6060-03-03	3/16"	3/16"	1.80		1
G6060-04-04	1/4"	1/4"	\$ 2.00	1.80	5
G6060-05-05	5/16"	5/16"	2.30	2.10	5
G6060-06-06	3/8"	3/8"	2.70	2.50	5
G6060-08-08	1/2"	1/2"		4.30	1
G6060-10-10	5/8"	5/8"		5.70	1
G6060-12-12	3/4"	3/4"		24.10	1

G6016... MALE CONNECTOR					
Pipe					
G6016-02-02	1/8"	1/8"	1.80	1.70	5
G6016-02-03	1/8"	3/16"		1.42	1
G6016-02-04	1/8"	1/4"	1.57	1.30	5
G6016-02-05	1/8"	5/16"	2.10	1.90	5
G6016-02-06	1/8"	3/8"		1.90	1
G6016-04-04	1/4"	1/4"	2.00	1.80	5
G6016-04-05	1/4"	5/16"		2.00	1
G6016-04-06	1/4"	3/8"	2.10	1.90	5
G6016-04-08	1/4"	1/2"		5.30	1
G6016-06-04	3/8"	1/4"		4.60	1
G6016-06-05	3/8"	5/16"		6.30	1
G6016-06-06	3/8"	3/8"	2.30	2.10	5
G6016-06-08	3/8"	1/2"		3.00	1
G6016-06-10	3/8"	5/8"		7.30	1
G6016-08-04	1/2"	1/4"		6.70	1
G6016-08-06	1/2"	3/8"		3.10	1
G6016-08-08	1/2"	1/2"		3.80	1
G6016-08-10	1/2"	5/8"		4.30	1
G6016-08-12	1/2"	3/4"		12.40	1
G6016-12-08	3/4"	1/2"		11.70	1
G6016-12-10	3/4"	5/8"		10.90	1
G6016-12-12	3/4"	3/4"		15.40	1

G6090... 90° UNION					
Tube					
G6090-02-02	1/8"	1/8"		10.90	1
G6090-03-03	3/16"	3/16"		8.00	1
G6090-04-04	1/4"	1/4"		5.10	1
G6090-05-05	5/16"	5/16"		5.70	1
G6090-06-06	3/8"	3/8"	4.50	4.10	5
G6090-08-08	1/2"	1/2"		6.50	1
G6090-10-10	5/8"	5/8"		9.50	1
G6090-12-12	3/4"	3/4"		28.00	1

7

Brass

BRASS COMPRESSION FITTINGS

Part Number	Pipe Size	Tube Size	PRICE EACH		Pkg Qty
			Loose	Std Pkg	
G6046... 45° MALE CONNECTOR					
					
G6046-02-03	1/8"	3/16"		\$ 9.00	1
G6046-02-04	1/8"	1/4"		7.10	1
G6046-02-05	1/8"	5/16"		8.60	1
G6046-04-04	1/4"	1/4"		7.10	1
G6046-04-06	1/4"	3/8"		7.80	1
G6046-06-08	3/8"	1/2"		10.80	1
G6046-08-08	1/2"	1/2"		18.90	1
G6046-08-10	1/2"	5/8"		20.50	1

G6098... 90° FEMALE CONNECTOR

					
G6098-02-04	1/8"	1/4"		5.10	1
G6098-02-05	1/8"	5/16"		7.00	1
G6098-04-06	1/4"	3/8"		6.30	1
G6098-04-08	1/4"	1/2"		13.40	1
G6098-06-04	3/8"	1/4"		8.10	1
G6098-06-06	3/8"	3/8"		8.10	1
G6098-06-08	3/8"	1/2"		10.90	1
G6098-08-06	1/2"	3/8"		9.50	1
G6098-08-08	1/2"	1/2"		14.10	1
G6098-08-10	1/2"	5/8"		14.90	1

G6096... 90° MALE CONNECTOR

					
G6096-02-02	1/8"	1/8"		3.30	1
G6096-02-03	1/8"	3/16"		3.60	1
G6096-02-04	1/8"	1/4"	2.30	2.00	5
G6096-02-05	1/8"	5/16"		4.50	1
G6096-02-06	1/8"	3/8"		3.10	1
G6096-04-03	1/4"	3/16"		5.70	1
G6096-04-04	1/4"	1/4"	3.10	2.90	5
G6096-04-05	1/4"	5/16"		4.60	1
G6096-04-06	1/4"	3/8"		3.20	1
G6096-04-08	1/4"	1/2"		7.00	1
G6096-06-04	3/8"	1/4"		7.00	1
G6096-06-05	3/8"	5/16"		8.10	1
G6096-06-06	3/8"	3/8"	3.90	3.60	5
G6096-06-08	3/8"	1/2"		7.30	1
G6096-06-10	3/8"	5/8"	9.00	7.80	5
G6096-08-04	1/2"	1/4"		10.10	1
G6096-08-06	1/2"	3/8"		8.30	1
G6096-08-08	1/2"	1/2"		5.70	1
G6096-08-10	1/2"	5/8"		8.00	1
G6096-08-12	1/2"	3/4"		26.10	1
G6096-12-08	3/4"	1/2"		18.40	1
G6096-12-12	3/4"	3/4"		26.70	1

G60T00... UNION TEE

					
	Tube Size				
G60T00-02-02	1/8"	1/8"		7.10	1
G60T00-03-03	3/16"	3/16"		7.00	1
G60T00-04-04	1/4"	1/4"		3.80	1
G60T00-05-05	5/16"	5/16"		7.00	1
G60T00-06-06	3/8"	3/8"		5.20	1
G60T00-08-08	1/2"	1/2"		12.60	1
G60T00-10-10	5/8"	5/8"		14.40	1
G60T00-12-12	3/4"	3/4"		59.30	1

G60T06... MALE BRANCH TEE

					
G60T06-02-02	1/8"	1/8"		\$ 9.10	1
G60T06-02-03	1/8"	3/16"		6.10	1
G60T06-02-04	1/8"	1/4"		5.70	1
G60T06-02-05	1/8"	5/16"		9.00	1
G60T06-04-04	1/4"	1/4"		7.10	1
G60T06-04-05	1/4"	5/16"		9.10	1
G60T06-04-06	1/4"	3/8"		7.50	1
G60T06-06-06	3/8"	3/8"		10.90	1
G60T06-06-08	3/8"	1/2"		14.70	1
G60T06-08-08	1/2"	1/2"		18.10	1
G60T06-08-10	1/2"	5/8"		23.70	1
G60T06-08-12	1/2"	3/4"		49.70	1
G60T06-12-12	3/4"	3/4"		52.00	1

G60T60... MALE RUN TEE

					
G60T60-02-04	1/8"	1/4"		5.70	1
G60T60-02-05	1/8"	5/16"		9.10	1
G60T60-04-04	1/4"	1/4"		8.30	1
G60T60-04-05	1/4"	5/16"		9.20	1
G60T60-04-06	1/4"	3/8"		8.30	1
G60T60-06-06	3/8"	3/8"		12.50	1
G60T60-06-08	3/8"	1/2"		15.60	1
G60T60-08-08	1/2"	1/2"		19.30	1
G60T60-08-10	1/2"	5/8"		20.40	1
G60T60-08-12	1/2"	3/4"		49.30	1
G60T60-12-12	3/4"	3/4"		44.30	1

7

Brass